

WE ARE **25**



2021
THE ENTIRE RANGE OF
DECORATIVE PROFILES

DEAR FRIENDS, CUSTOMERS, PARTNERS:

Trade Information Service is a full-cycle manufacturing company making polymeric products for various industries, active since 1995.

Our company offers own-manufactured, European-quality products made using advanced technologies. We choose a creative approach to our production tasks, developing new products that keep up with the times and improving the quality of our service. We take maximum efforts to continuously improve the qualification of our personnel.

Our company's production potential also includes an own laboratory, logistic infrastructure, original designs and highly-skilled personnel continuously striving for kaizen-style improvements and capable of finding the best solutions in the optimal time.



We are always open and happy to meet every one of you!



Why us?

- Active since 1995;
- Cost-effective production using kaizen practices;
- ISO-certified;
- Domestic manufacture;
- Individual approach to every customer;
- Modern production equipment;



CONTENTS

PVC

BASEBOARDS

| | |
|---|----|
| 56 mm box baseboard with flexible edges | 7 |
| 48 mm economy box baseboard with flexible edges | 8 |
| Bathroom profile | 9 |
| Kitchen baseboard | 10 |
| Installing a baseboard | 11 |
| DECORATIVE ANGLES | 12 |
| External angle for ceramic tiles | 13 |
| Internal angle for ceramic tiles | 14 |
| Universal angle | 14 |
| External angle | 15 |
| DECORATIVE THRESHOLD | 16 |
| Decorative threshold | 17 |
| Installing a threshold | 17 |

ALUMINUM

THRESHOLDS

| | |
|---|----|
| 20 mm smooth threshold | 18 |
| 28 mm smooth threshold with hidden fastening system | 19 |
| 30 mm smooth threshold | 19 |
| 40 mm smooth threshold | 20 |
| 25 mm fluted threshold | 20 |
| 30 mm fluted threshold | 21 |
| 40 mm fluted threshold | 21 |
| 50 mm fluted threshold | 22 |
| 50 mm threshold with anti-slipping insert | 22 |
| | 23 |

| | |
|---|----|
| Installing a threshold | 24 |
| STAIR PROFILE | 25 |
| 25×20 mm fluted profile | 26 |
| 45×22 mm fluted profile | 26 |
| 50×23 mm profile with anti-slipping insert | 27 |
| 65×36 mm profile with anti-slipping insert and LED illumination | 27 |
| PROFILES FOR CERAMIC TILES | 28 |
| 13 mm T-shaped profile (AT-13) | 29 |
| 18 mm T-shaped profile (AT-18) | 29 |
| 10 mm external angular profile (NAP-10) | 30 |
| 12 mm external angular profile (NAP-12) | 30 |
| 10 mm internal angular profile (VAP) | 31 |
| Connecting profile (APZ) | 31 |
| Overlapping profile (OAP) | 32 |
| Straight facing profile (AP) | 32 |
| Flexible shaped profile (APG) | 33 |
| 10×10 mm stair profile (ELK) | 33 |
| 10×12 mm stair profile (APZR) | 34 |
| 24×12 mm stair Z-profile (ALPZ) | 34 |
| Decorative angles | 35 |
| Universal angle (AK) | 36 |
| NOTES | 37 |
| OTHER TIS PRODUCTS | |
| LED program LP | 38 |

PICTOGRAMS AND THEIR SYMBOLS



1. Wood effect



2. Wood structure



3. Flexible edge, leveling insignificant unevenness



4. Fastening options: (several fastening options can be combined)



- Wall plugs with screws;



- Glue;



- Adhesive tape;



- Stapler;



5. Low water absorption



6. Resistant to insignificant mechanical shocks



7. Wire change without dismantling the baseboard



8. Broad color range



9. Availability of relevant hardware



10. Wall plugs and screws enclosed (for 0.9 m and 1.8 m lengths)



11. Contains no lead



12. Recyclable

BASEBOARDS



Plastic baseboards are used simultaneously as functional and as decorative elements intended to mask the places where the floor joins walls and to protect these joints from water, dust and dirt getting inside them.

The "box" function allows to install electrical wires without heavy construction work and without dismantling the baseboards. No painting required; durable and easy to maintain.

56 MM BOX BASEBOARD WITH FLEXIBLE EDGES (PLG)

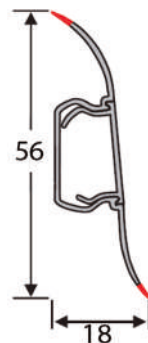

Length: 2,5 m
Set: 40 pc. - 100 running meters

ANGULAR AND FINISHING ELEMENTS FOR THE BASEBOARD

EXTERNAL CORNER



INTERNAL CORNER



LEFT EDGE



RIGHT EDGE



JOINT



AVAILABLE COLORS FOR BASEBOARDS AND ELEMENTS

| WHITE | BLACK | ORLANDO BEECH | CLASSICAL WENGE | BLACK WENGE | COUNTRY OAK | ASH | | | |
|---------------|-------|-----------------|-----------------|------------------|-------------------|------------|-------|--------|------|
| 0101 | 0062 | 0006 | 0051 | 0063 | 0003 | 0015 | | | |
| VANCOUVER OAK | | CLASSICAL ALDER | CASTLE OAK | BRAZILIAN WALNUT | RAVENNA OAK | ARCTIC OAK | | | |
| 0085 | | 0013 | 0029 | 0025 | 0084 | 0087 | | | |
| AFRICAN OAK | | WHITE OAK | CARBALLO OAK | COMO OAK | LIGHT CORDOBA OAK | GREY OAK | | | |
| 0072 | | 0014 | 0050 | 0028 | 0009 | 0088 | | | |
| MORGAN OAK | | PREMIUM OAK | ROVERE OAK | STEPPE OAK | SHERWOOD OAK | DARK OAK | | | |
| 0026 | | 0027 | 0049 | 0030 | 0008 | 0086 | | | |
| MAHOGANY | | ROSEWOOD | LIGHT OAK | SILVER TEAK | ELM | MAPLE | WENGE | WALNUT | |
| 0041 | | 0017 | 0024 | 0070 | 0016 | 0044 | 0083 | 0004 | 0040 |

48 MM ECONOMY BOX BASEBOARD WITH FLEXIBLE EDGES (PLGE)

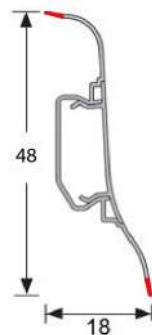

Length: 2,5 m

Set: 40 pc - 100 running meters

ANGULAR AND FINISHING ELEMENTS FOR THE BASEBOARD

EXTERNAL CORNER

INTERNAL CORNER

LEFT EDGE

RIGHT EDGE

JOINT



AVAILABLE COLORS FOR BASEBOARDS AND ELEMENTS

* CHERRY

ELM

BAROQUE WALNUT

WALNUT

* DARK WALNUT

WHITE OAK

0020

0044

0053

0040

0063

0014

ANTIQUE OAK

CORK OAK

* ROVERE OAK

DACHA OAK

* TEAK

* ROSEWOOD

0031

0054

0049

0032

0016

0017

CHESTNUT

MAHOGANY

0043

0041

NOTE

* - Color available on order only

BATHROOM PROFILE (POV)

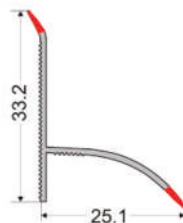

Length: 1,8 m

Set: 30 pc - 54 running meters

ANGULAR AND FINISHING ELEMENTS FOR THE BASEBOARD

INTERNAL CORNER

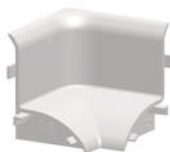

LEFT EDGE



RIGHT EDGE



AVAILABLE COLORS FOR BASEBOARDS AND ELEMENTS

WHITE

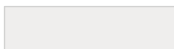

KITCHEN BASEBOARD (PK)

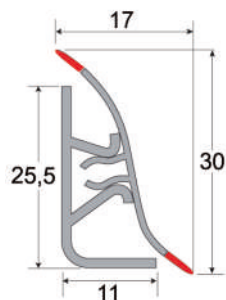

Length: 3 m

Set: 20 pc - 60 running meters

ANGULAR AND FINISHING ELEMENTS FOR THE BASEBOARD

INTERNAL CORNER

LEFT EDGE

RIGHT EDGE



AVAILABLE COLORS FOR BASEBOARDS AND ELEMENTS

WHITE

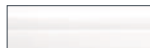

ORLANDO BEECH



SHERWOOD OAK



SILVER



INSTALLING A BASEBOARD

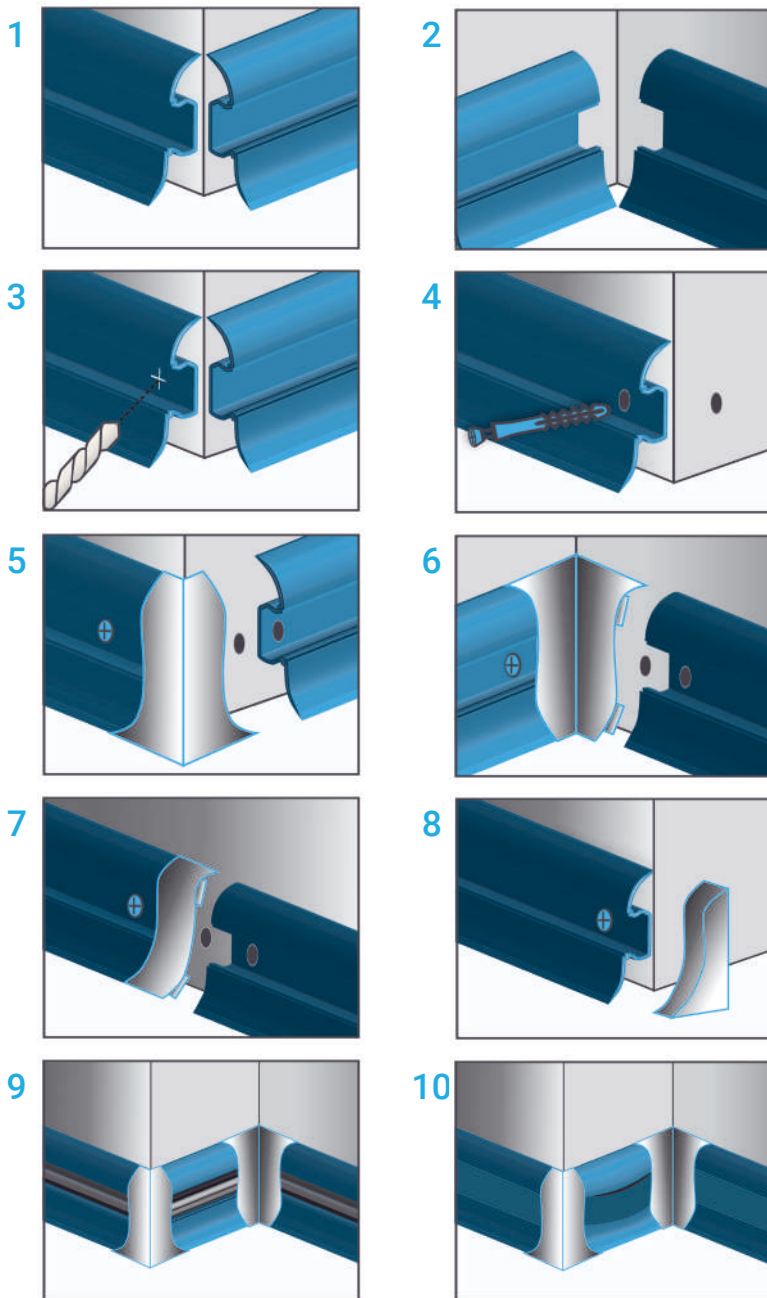

DECORATIVE ANGLES



Decorative angles are indispensable elements of design, used in almost every renovation work. Our angles are reliable and resistant to external impact; they do not fade and do not change their color.

EXTERNAL ANGLE FOR CERAMIC TILES (PPN)

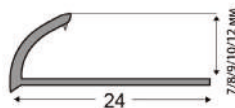

Length: 2,5 m

Set: 40 pc - 100 running meters

WHITE*

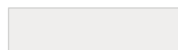

LIGHT BEIGE



VANILLA



DARK BEIGE



JASMINE*



BEIGE



CARAMEL



GREY



BROWN



* - 7 mm, 10 mm, 12 mm available in white and jasmine colors only

INTERNAL ANGLE FOR CERAMIC TILES (PPV)

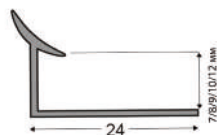

Length: 2,5 m

Set: 40 pc - 100 running meters

WHITE*

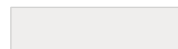

LIGHT BEIGE



VANILLA



DARK BEIGE



JASMINE*



BEIGE



CARAMEL



GREY



BROWN



* - 7 mm, 10 mm, 12 mm available in white and jasmine colors only

UNIVERSAL ANGLE (POU)

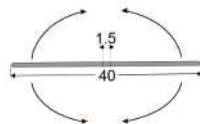
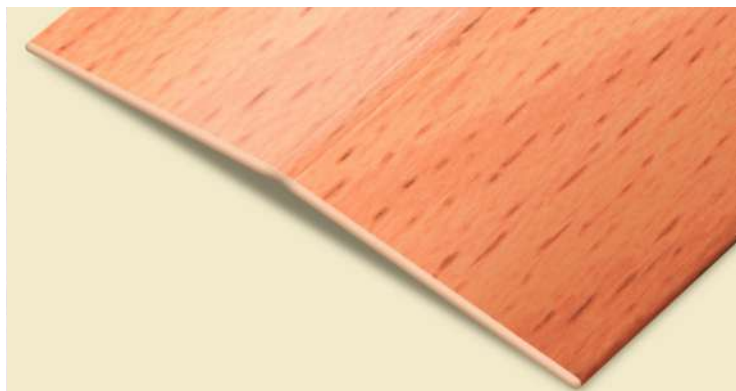

Length: 2,5 m

Set: 40 pc - 100 running meters

WHITE

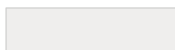

WALNUT



ALDER



SHERWOOD OAK



MAPLE



EXTERNAL ANGLE (PO)

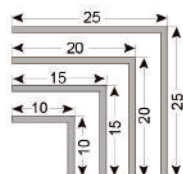

Length: 2,75 m

Set: 40 pc - 110 running meters

WHITE

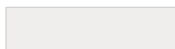

JASMINE*



CARAMEL*



* - Available in 20x20 mm size

DECORATIVE THRESHOLD



A PVC threshold is designed to conceal the joint between two floor coverings. It adds completeness to the interior, and comes in a variety of colors. The threshold coating precisely imitates wood, which allows to select a threshold that closely matches the shade of the floor itself.

Ideal to conceal joints on linoleum, laminate flooring, parquet, carpeting and countless other floor coverings.

DECORATIVE THRESHOLD (PO32S)



Length: 0,9 m

CLASSICAL WENGE



WALNUT



COMO OAK



MORGAN OAK



LIGHT OAK



STEPPE OAK



SHERWOOD OAK



TEAK



INSTALLING A THRESHOLD

1

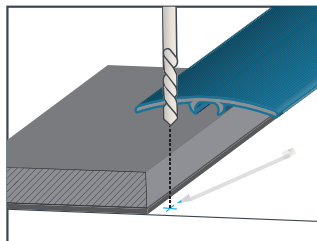

2

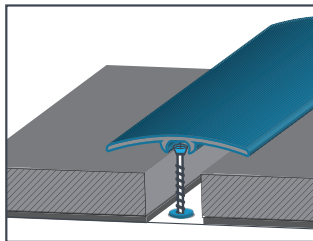

3

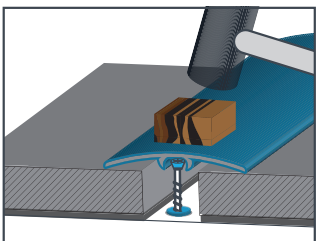

4

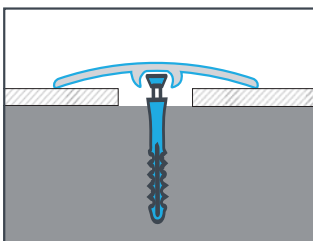

THRESHOLDS



Aluminum thresholds are designed to join and protect floor coverings in joint places, giving the interior completed appearance.

TIS offers various threshold models, each designed to serve an individual purpose: smooth, fluted, single-level, different-level, self-adhesive, with hidden fastening system, with anti-slipping insert, etc.

20 MM SMOOTH THRESHOLD (A020G)

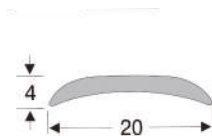

Length:
2,7 m; 1,8 m; 0,9 m;

BRONZE



GOLD



SILVER



28 MM SMOOTH THRESHOLD WITH HIDDEN FASTENING SYSTEM (A028S)

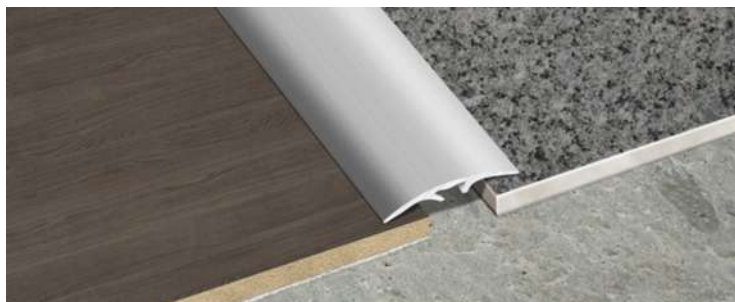

Length:
2,7 m; 1,8 m; 0,9 m;

BRONZE GLOSS



BRONZE



GOLD GLOSS



GOLD



SILVER GLOSS



SILVER



30 MM SMOOTH THRESHOLD (AO30G/AOD30G)

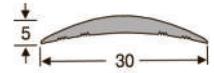

Length:
2,7 m; 1,8 m; 0,9 m;

BRONZE



GOLD



SILVER



GREY WALNUT



WENGE



MAPLE



WHITE OAK



Light OAK



GREY OAK



DARK OAK



ASPEN OAK



SHERWOOD OAK



OAK



CREAM OAK



TEAK



WALNUT



40 MM SMOOTH THRESHOLD (AO40G)

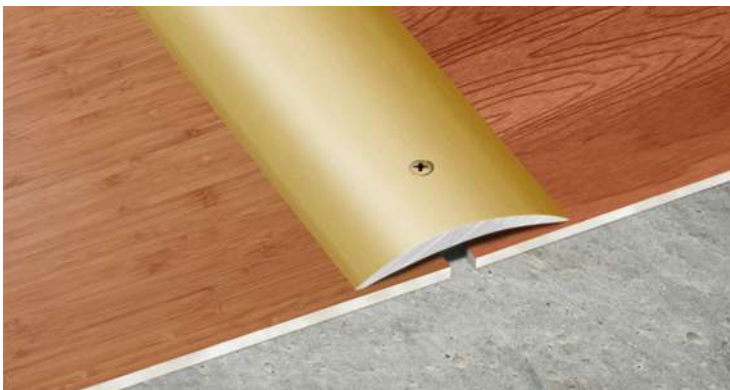

Length:
2,7 m; 1,8 m; 0,9 m;

BRONZE



GOLD



SILVER



25 MM FLUTED THRESHOLD (A025R)



Length:
2,7 m; 1,8 m; 0,9 m;

BRONZE



GOLD



SILVER



30 MM FLUTED THRESHOLD (A030R)

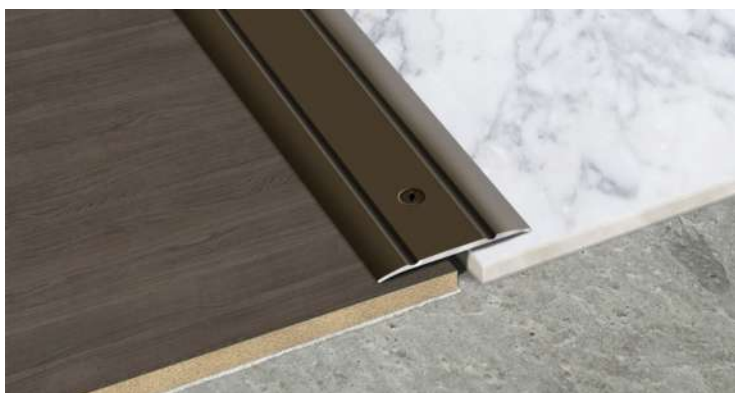

Length:
2,7 m; 1,8 m; 0,9 m;

BRONZE



GOLD



SILVER



40 MM FLUTED THRESHOLD (AO40R)



Length:
2,7 m; 1,8 m; 0,9 m;

BRONZE



GOLD



SILVER



50 MM FLUTED THRESHOLD (AO50R)

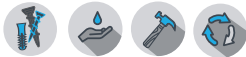

Length:
2,7 m; 1,8 m; 0,9 m;

BRONZE



GOLD



SILVER



50 MM THRESHOLD WITH ANTI-SLIPPING INSERT (A050V)

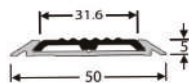

Length:
1 m; 2 m;

NO COATING



INSTALLING A THRESHOLD

OPTION A (OPEN FASTENING)

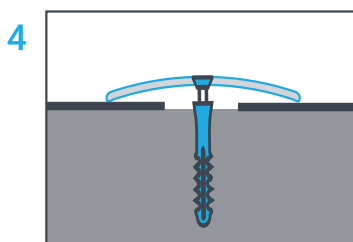
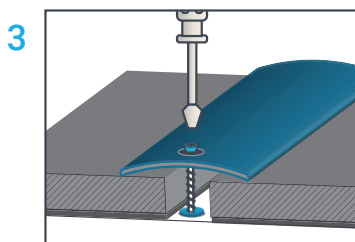
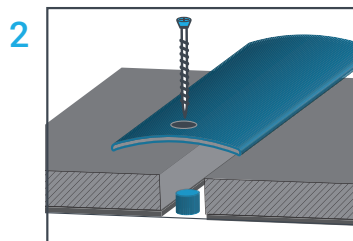
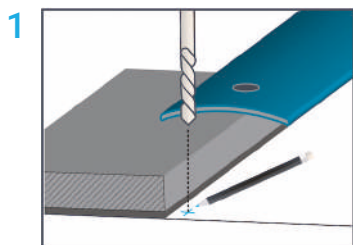

OPTION B (HIDDEN FASTENING)

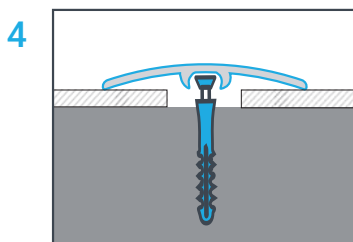
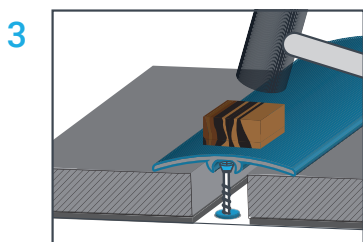
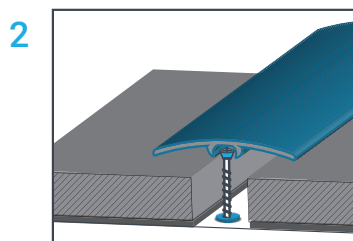
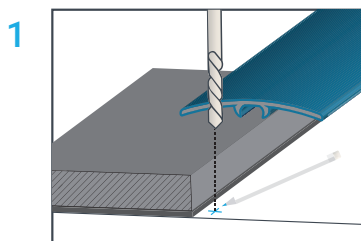

STAIR PROFILE



Aluminum stair profiles are used for protection and decoration of stairs and podiums when laying tiles, laminate flooring, parquet, linoleum or carpeting. Our profiles are available in various colors and surface types.

25x20 MM FLUTED PROFILE (AS20/ASD20)

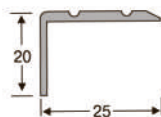

Length:
2,7 m; 1,8 m; 0,9 m;

MAPLE



BRONZE



GOLD GLOSS



GOLD



SILVER GLOSS



SILVER



WALNUT



GREY WALNUT



WENGE



CREAM OAK



WHITE OAK



LIGHT OAK



DARK OAK



ASPEN OAK



GREY OAK



SHERWOOD OAK



OAK



TEAK



45x22 MM FLUTED PROFILE (AS22)

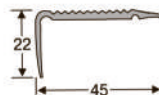

Length:
2,7 m; 0,9 m;

BRONZE



GOLD



SILVER



50x23 MM PROFILE WITH ANTI-SLIPPING INSERT (AS50V)

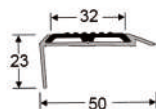

NO COATING

Length:
2 m; 1 m;

65x36 MM PROFILE WITH ANTI-SLIPPING INSERT AND LED ILLUMINATION (LPUU)

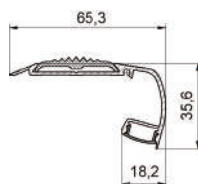
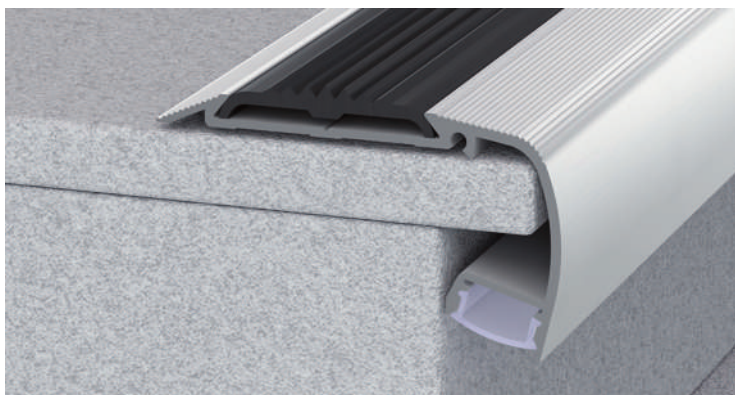

SILVER

Length:
2 m;

PROFILES FOR CERAMIC TILES



Profiles for ceramic tiles are installed when laying ceramic tiles. They protect corners, giving esthetic completeness to walls and stairs and extending the service life of ceramic tiles.

13 MM T-SHAPED PROFILE (AT13)

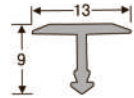

Length: 2,7 m

GOLD



SILVER



BRONZE



POLISHED



18 MM T-SHAPED PROFILE (AT18)

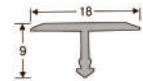
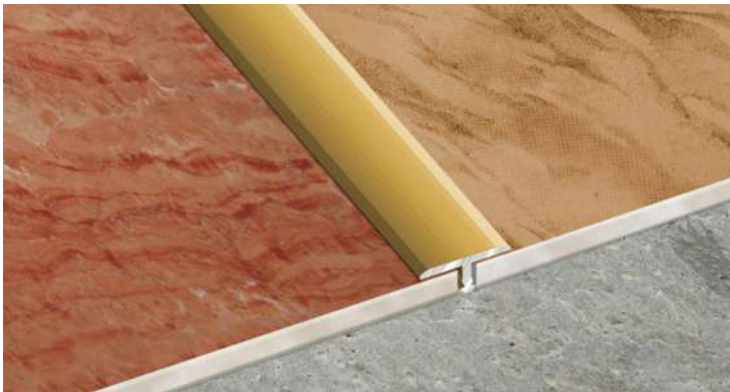

Length: 2,7 m

GOLD



SILVER



BRONZE



POLISHED



10 MM EXTERNAL ANGULAR PROFILE (NAP10)

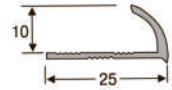

Length: 2,7 m

CHAMPAGNE



BRONZE



GOLD GLOSS



GOLD



POLISHED



SILVER GLOSS



SILVER



SILVER BRUSHED



12 MM EXTERNAL ANGULAR PROFILE (NAP12)



Length: 2,7 m

BRONZE



GOLD



POLISHED



SILVER



10 MM INTERNAL ANGULAR PROFILE (VAP)

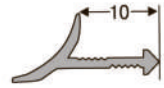

Length: 2,7 m

BRONZE GLOSS



BRONZE



GOLD GLOSS



GOLD



POLISHED



SILVER GLOSS



SILVER



CONNECTING PROFILE (APZ)



Length: 2,7 m

BRONZE



GOLD



POLISHED



SILVER



OVERLAPPING PROFILE (OAP)

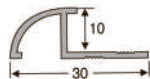

Length: 2,7 m

SILVER

BRONZE

GOLD

POLISHED



STRAIGHT FACING PROFILE (AP)

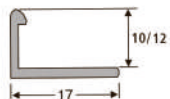

Length: 2,7 m

SILVER

BRONZE

GOLD

POLISHED



FLEXIBLE SHAPED PROFILE (APG)

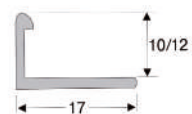
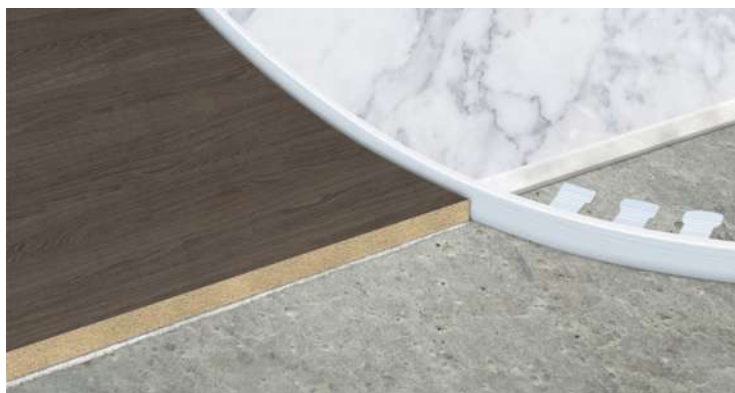

Length: 2,7m

BRONZE



GOLD



POLISHED



SILVER



10×10 MM STAIR PROFILE (ELK)

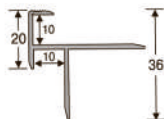

Length: 2,7 m

BRONZE



GOLD



SILVER



10×12 MM STAIR PROFILE (APZR)

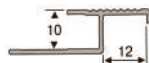

Length: 2,7 m

NO COATING



BRONZE



GOLD



SILVER



24×12 MM STAIR Z-PROFILE (ALPZ)

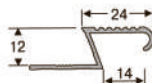

Length: 2,7 m

NO COATING



BRONZE



GOLD



SILVER





Decorative angles are used at the final stages of design work to conceal the existence of internal or external joints and protect corners against damage. They have a long service life.

LED PROFILES

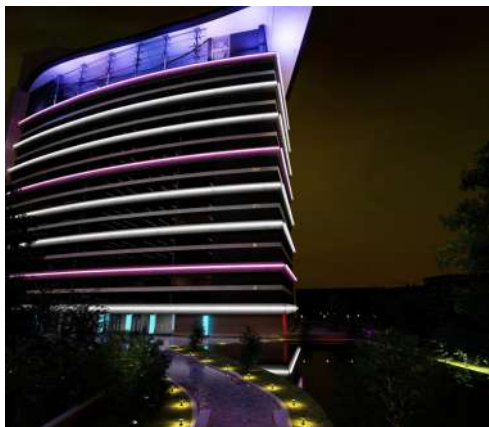

LED profiles from TIS offer broad opportunities for the use of LED lighting in decorative illumination of furniture and vending equipment, private, commercial and public facilities, advertisements, greenhouses, aquariums, light tuning of motor vehicles and yachts, and for many other purposes.

Our LED profiles are intended for technological installation of LED ribbons, direction and concentration of luminous flux, exclusive lighting design (both indoors and outdoors), and also, they ensure heat removal necessary for the lasting performance of light-emitting diodes. We are always open and happy to meet every customer!

For information about our products, visit our website at www.lprof.com.

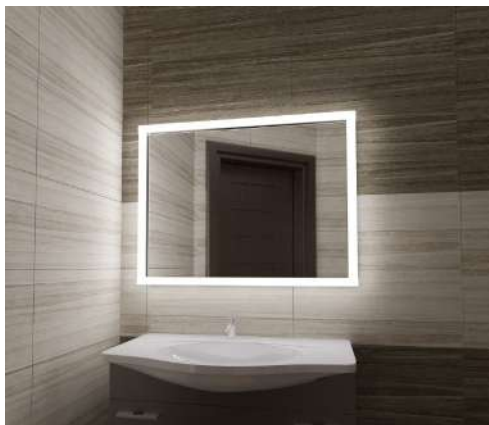





2021

THE ENTIRE RANGE
OF DECORATIVE
PROFILES



CONTACTS:
vul. Mashynobudivnykiv 1
Chabany, Kyiv Oblast, 08162

TEL: +38 044 251-05-81; 82; 83
WWW.TISPROFILE.COM